

DATASHEET

XS4 ORIGINAL+ by SALTO

The XS4 Original+ product is a universal state of the art electronic escutcheon that brings the smart lock to a new technology level, combining the latest innovations in security, connectivity and design into a battery operated access control device.

www.saltosystems.com

TECHNICAL SPECIFICATIONS:

XS4 ORIGINAL+ SM6xx

SALTO
inspired access



(*) Optional

TECHNICAL DATA:

Reader dimensions (H x W x D):	290,0 x 67,0 x 20,0 mm
Weight	2,5 kg
Handle rotation:	52°
Door thicknesses:	32 – 120 mm
Axes distance Scandinavian Oval cylinder:	105 Cylinder (Outside only) and 105 Thumbturn (Inside)
Square spindles:	8mm, 8mm split.
Power source:	3 LR6 batteries (AA size) (optional lithium FR06 batteries)
Number of openings:	40,000 - 60,000 (to be confirmed)
Maximum events on lock audit	2 000 (SVN standalone mode) 1 625 (SVN BLUEnet mode) 1 280 (SALTO KS mode)
Environmental conditions Outdoor:	-35 °C / +60 °C without condensation
Environmental conditions Indoor:	-5 °C / +50 °C without condensation (optional -35°C / +60°C)
IP class:	IP54 (optional E5 - IP56*)
Certifications:	CE, FCC/IC, RCM, EAC, EN 179, EN 1634-1 (Ei30, Ei60), EN16867 47-B24D00**, EN16867 47_B24D11***

* External escutcheon

** Pending 47-B24D01

*** Pending 47-B24D12

CREDENTIAL TECHNOLOGIES:

SALTO JustIN Mobile Credentials ¹ :	•
NXP MIFARE ² :	•
HID ³ :	—
LEGIC ⁴ :	—

¹ Mobile Key Bluetooth and Near Field Communication (NFC) capability.² MIFARE[®] DESFire[®] EV1/EV2/ EV3, MIFARE[®] Plus, MIFARE[®] Ultralight C, MIFARE[®] Classic.³ iCLASS[®], Seos[®].⁴ Legic Prime, Legic Advant.**CORE TECHNOLOGIES:**

SALTO Native Bluetooth LE wireless connectivity:	•
Hardware Secure Element:	•

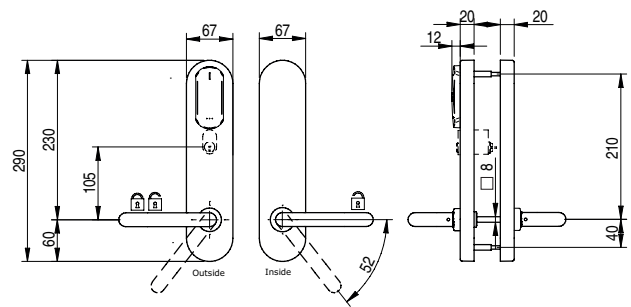
TECHNICAL DRAWING:**PLATFORMS:****SALTO Space:**

ROM	—
SVN data-on-card	•
Wireless (SALTO RFnet)	—
Wireless (SALTO BLUEnet)	•
SVN-Flex	•

SALTO KS:

Wireless (SALTO RFnet):	—
Wireless (SALTO BLUEnet):	•

OPTIONS:**Reader finish:**

Black:	•
White:	•

Finish:

IM Satin stainless steel:	•
IP Bright stainless steel:	•
PP PVD bright brass type:	•
PM PVD satin brass type:	•
NE Black chromium:	•
DB Dark Bronze:	•
BC BioCote anti-microbial:	•

Handles

Compatible handles*	U, L, W, H, S, B, P, J, T, Y, O, N, G, K, 2, 3, 4, 7, 5
High Transit:	• (optional)

* Not all the handles are available in all finishes.

Locks:

Euro-DIN:	—
ANSI:	—
Scandinavian:	•
Cylindrical:	—
Tubular:	—

MODELS:

MODEL 50:

- 2 handles any type.

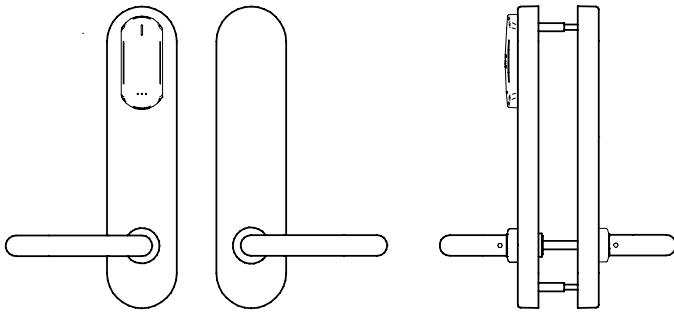

MODEL 55:

- 2 handles any type.
- Outside cylinder cut out.
- Inside thumbturn.

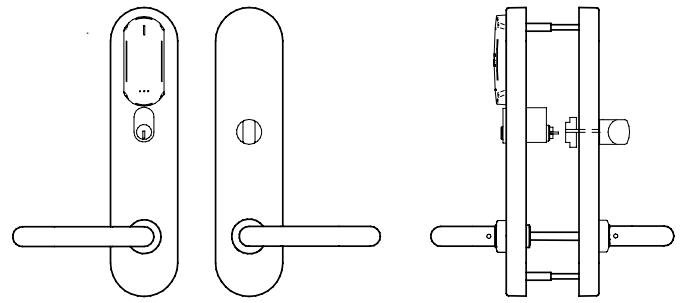

MODEL 51:

- 2 handles any type.
- Inside thumbturn.

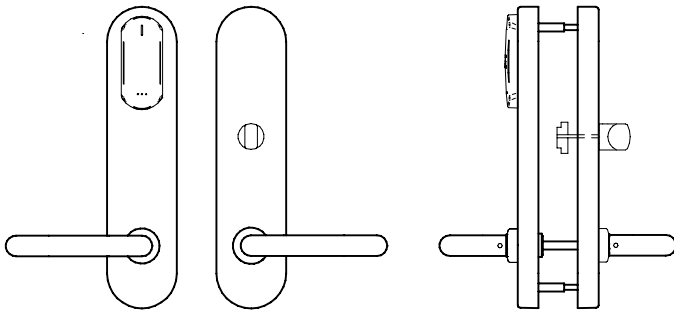

MODEL 56:

- 2 handles any type.
- Electronic "do not disturb" system (Not available in self-programmable).

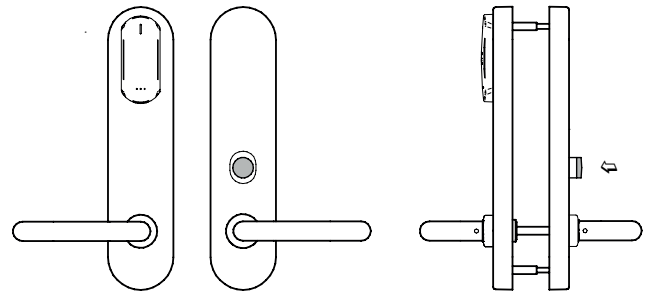

MODEL 54:

- 2 handles any type.
- Outside cylinder cut out.

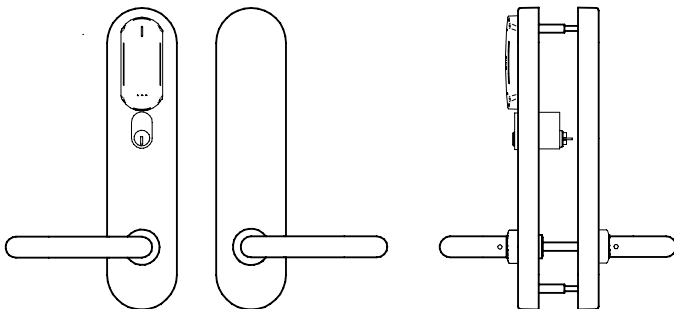

MODEL 57:

- 2 handles any type.
- Outside cylinder cut out.
- Electronic "do not disturb" system (Not available in self-programmable).

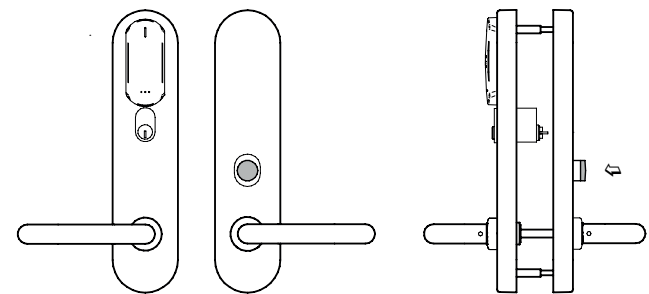

MODELS:

MODEL 78:

- 2 handles any type.
- Inside thumbturn.
- Built in mechanical override and cover with audit. (Mortise cylinder 1 1/8").

